

DEFLECTION ANGLE, 'A' (°)	MAX TENSION (kg)
10	8610
15	5750
30	2900
45	1960
60	1500
90	1060

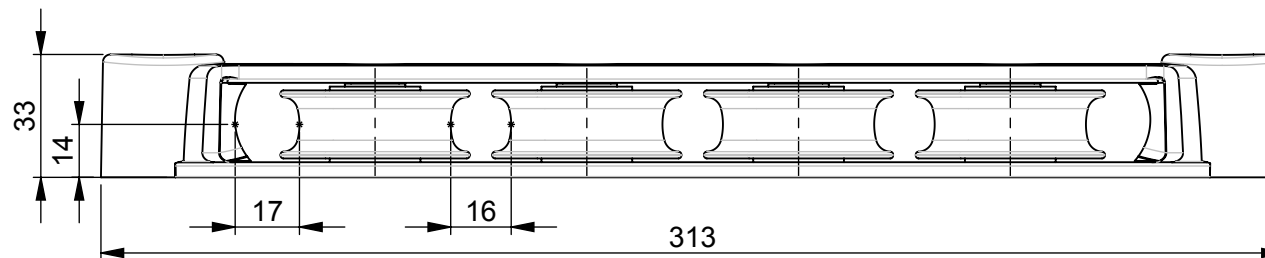

spinlock
BE ADVENTURE-PROOF

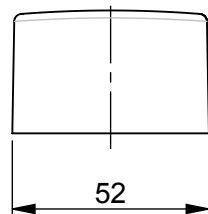
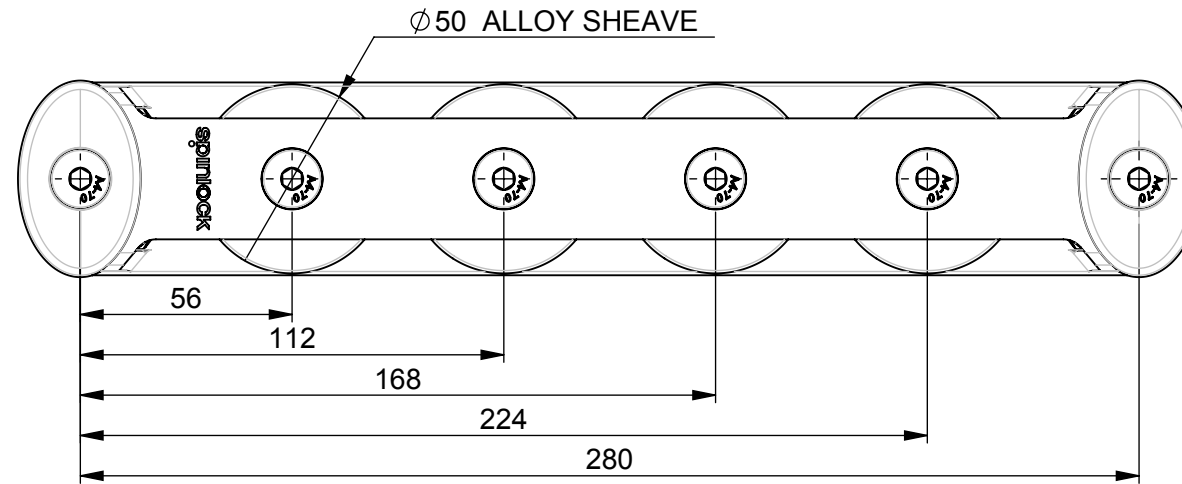

WARNING:
IF USING AS A DRILL TEMPLATE, ENSURE PRINTER SETTINGS ARE ADJUSTED TO ACCOUNT FOR THE DRAWING SCALE AND **ALWAYS** CHECK DIMENSIONS BEFORE DRILLING.



COPYRIGHT:
THIS DRAWING IS PROTECTED BY COPYRIGHT. ANY USE IS FORBIDDEN WITHOUT THE WRITTEN CONSENT OF SPINLOCK.

ALL DIMENSIONS IN MM

SCALE	PAGE SIZE	DATE
1:2	A4	APR 2018

MAX LINE SIZE

Ø 14mm

FASTENERS

M8 CSK
x 6

WEIGHT

900g

SWL PER
SHAVE

1500kg

TOTAL SWL
PER UNIT

3000kg

TC50/4

FOR MORE INFO CONTACT
SPT@SPINLOCK.CO.UK