

DEFLECTION ANGLE

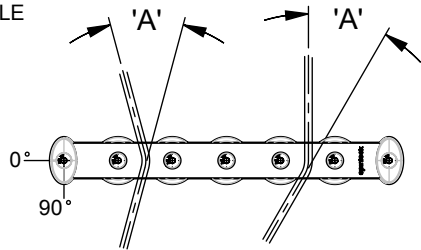

BISECTED ROPE ENTRY

STRAIGHT ROPE ENTRY

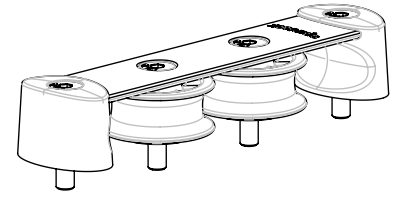

DEFLECTION ANGLE, 'A' (°)	MAX ROPE TENSION (KG)
10	3440
15	2300
30	1160
45	780
60	600
90	420

Ø 38 COMPOSITE SHEAVE (T38/2)
ALLOY SHEAVE (T38/2A)

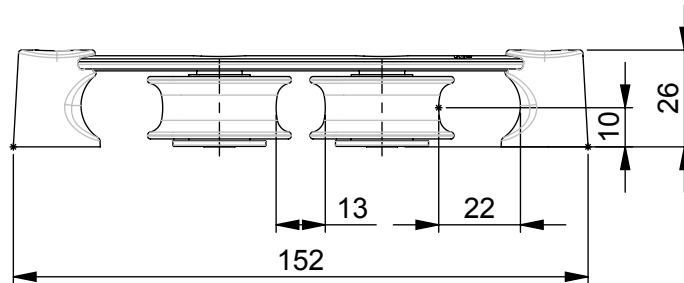
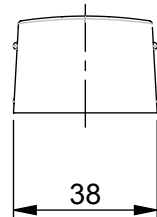
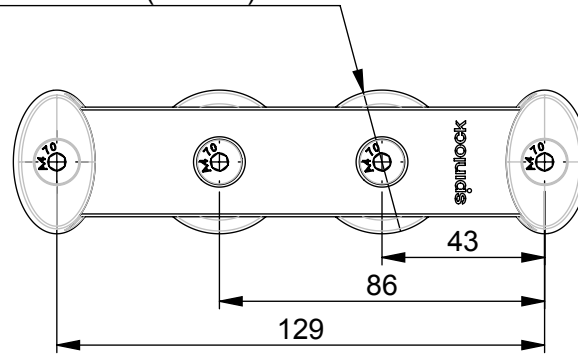

spinlock
BE ADVENTURE-PROOF



WARNING:
IF USING AS DRILL TEMPLATE, ENSURE PRINTER SETTINGS ARE ADJUSTED TO ACCOUNT FOR THE DRAWING SCALE AND **ALWAYS** CHECK DIMENSIONS BEFORE DRILLING.



COPYRIGHT:
THIS DRAWING IS PROTECTED BY COPYRIGHT. ANY USE IS FORBIDDEN WITHOUT THE WRITTEN CONSENT OF SPINLOCK.

ALL DIMENSIONS IN MM

SCALE PAGE SIZE DATE

1:2

A4

MAR 2018

LINE SIZE:
6-12mm
FASTENERS
M6 CSK
x 4

PRODUCT CODE

T38/2

T38/2A

WEIGHT

115g

154g

MAX LOAD

600kg

600kg

MAX LOAD PER UNIT

600kg

600kg

T38/2

FOR ANY MORE INFO CONTACT
SPT@SPINLOCK.CO.UK