

Sprayhood attachment points on Deckvest

Note: Sprayhoods are fitted in front of bladder

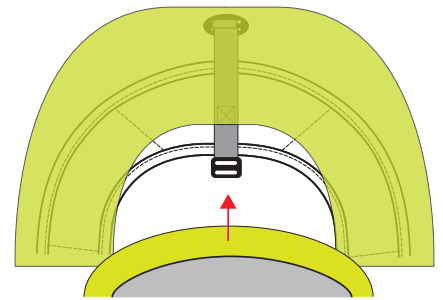

Deckvest Cento

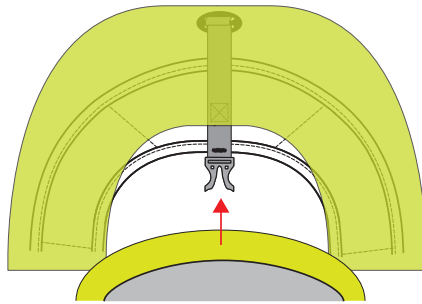
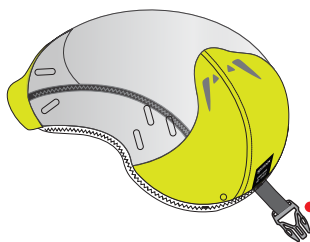

Adapter with Buckle

Sprayhood Buckle

1. Thread adapter through buckle

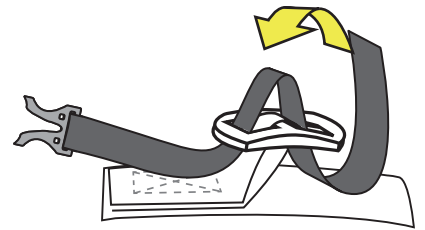

2. Then back over through buckle

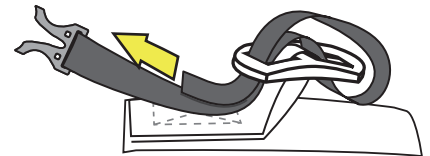

Note: Allow 70mm of webbing from buckle to sprayhood

Deckvest Lite pre 2017

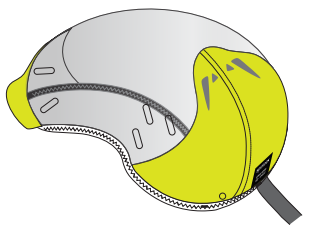

Sprayhood Buckle

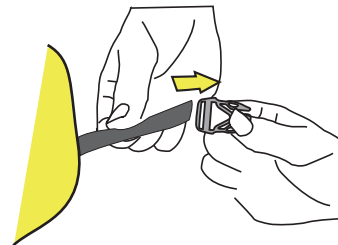

1. Thread buckle on to webbing

2. Clip buckle on sprayhood into buckle on Deckvest

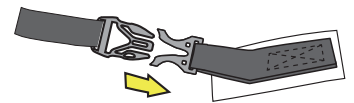

Deckvest Lite + / Lite 2017 > 5D and 6D 170N / 275N DURO / SOLAS

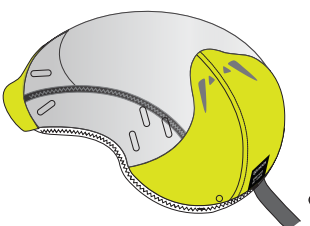

Sprayhood Buckle not required

1. Thread Webbing through buckle



2. Then back over through buckle

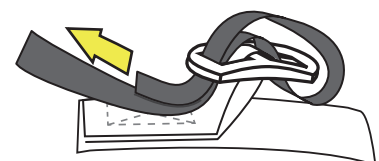

Note: Allow 70mm of webbing from buckle to sprayhood

Deckvest Vito

1. Take sprayhood and pass the two grey webbing pieces into holes on top of the bladder

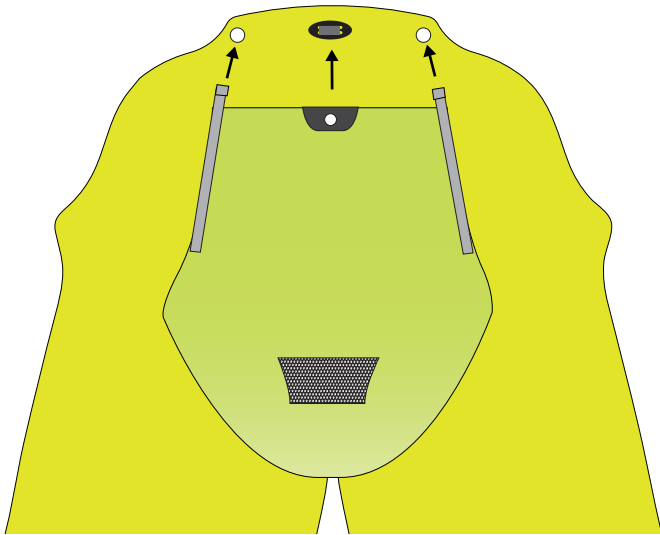

2. Pass the toggle on bladder through centre hole in sprayhood

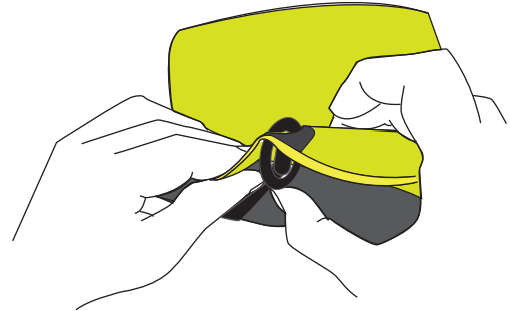

3. Take sprayhood lanyard and pass the toggle through the front centre hole in sprayhood.

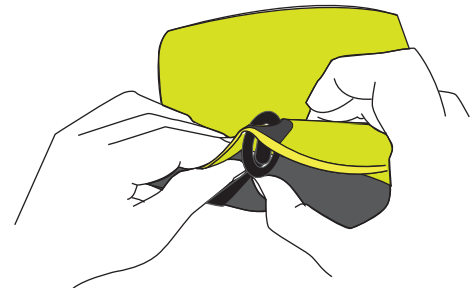
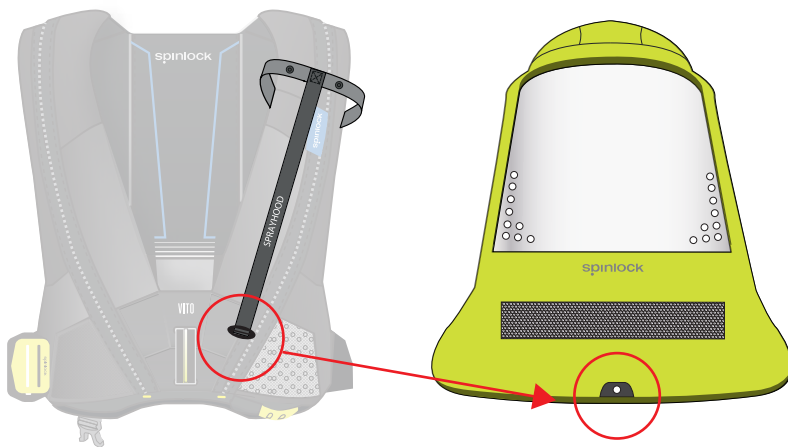

Sprayhood Repacking

1. Place jacket on its back and lay sprayhood out
2. Concertina top of sprayhood
3. Turn jacket over on its front and start to bend hoop section in on itself and push down into the back of jacket
4. Push sprayhood hoop down into pocket

